

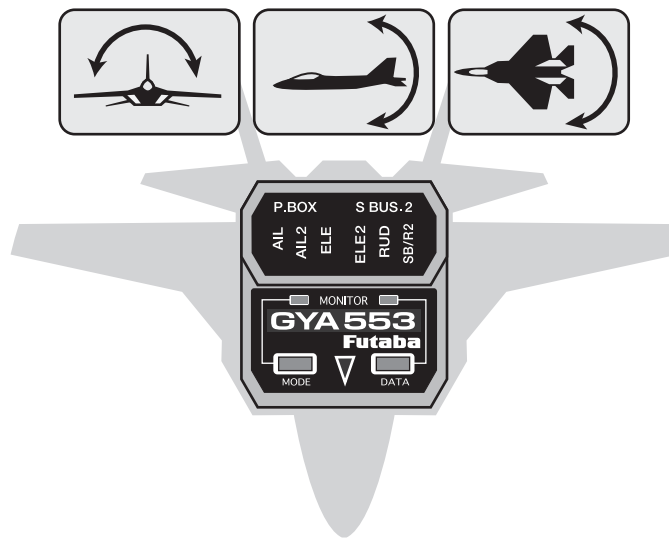

T32MZ

GYA553



T32MZ

GYA553 Ver.2

Setting manual

Futaba

1M23Z06823

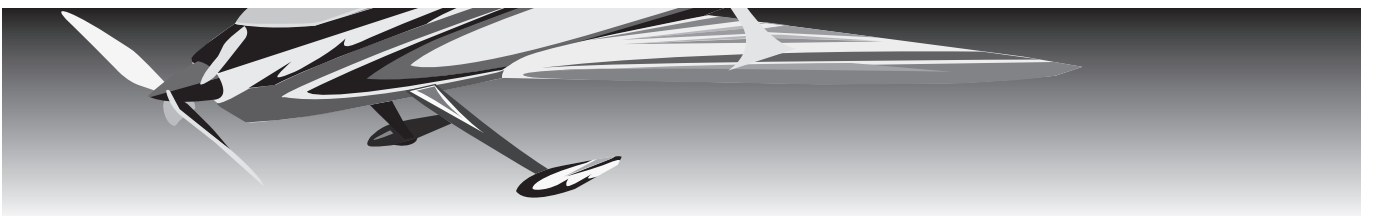

By installing the latest software (Ver. 3.6 ~) on the T32MZ, you can setting the airplane gyro GYA553 on the T32MZ.

Connection T32MZ and GYA553

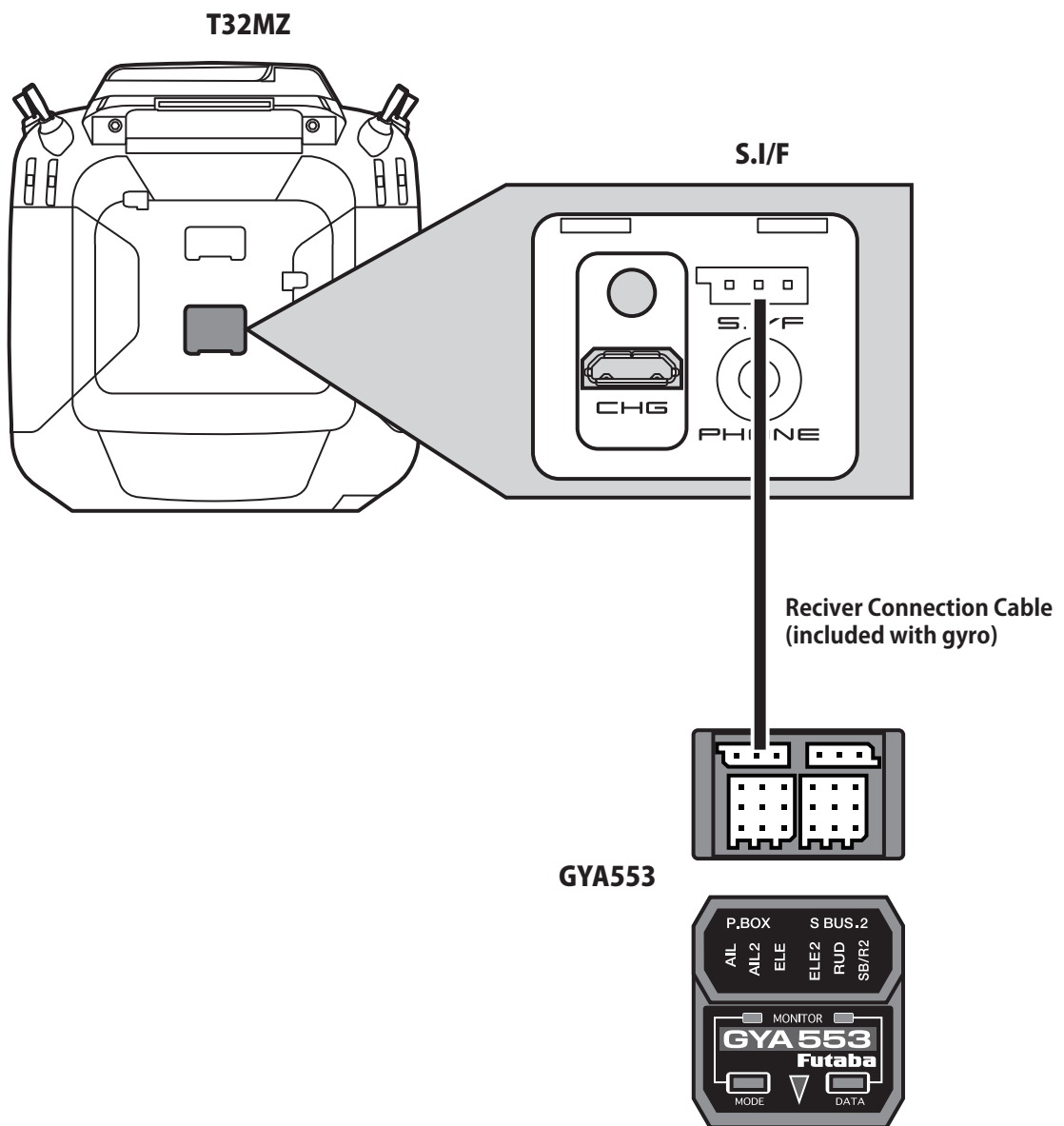

⚠ CAUTION

❗ Be sure to connect and disconnect the GYA553 and T32MZ connection cable with the power off.

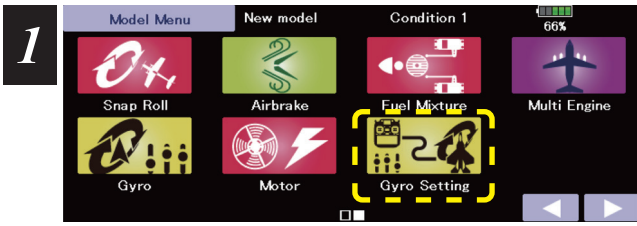

1 Select "Gyro setting" on the last page of Airplane Model Menu

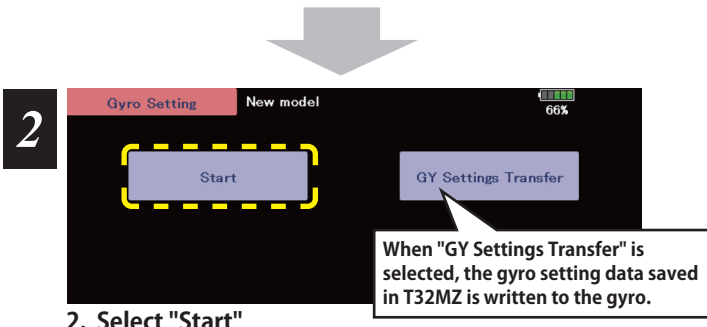

2 Select "Start"

When "GY Settings Transfer" is selected, the gyro setting data saved in T32MZ is written to the gyro.

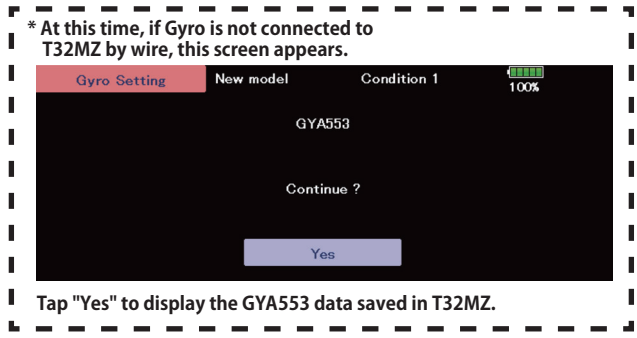

Tap "Yes" to display the GYA553 data saved in T32MZ.

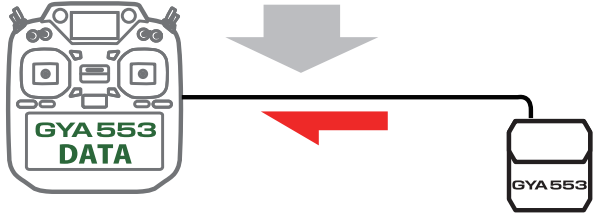

Select "Start"
This will download the gyro data to the T32MZ.



3 Home screen is displayed

To Basic menu

◆ When copying data from Gyro A to Gyro B

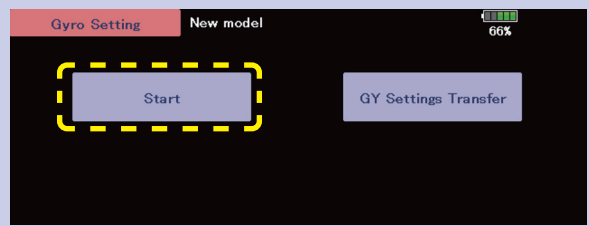

Connect the gyro A to the T32MZ and press [Start]. (Enter the data of A into T32MZ)

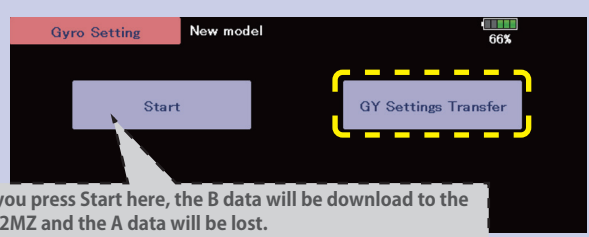
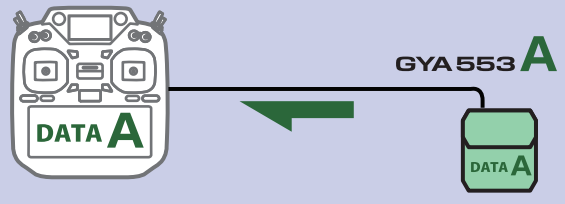

Connect Gyro B to T32MZ and press [GY Settings Transfer]. (Put data on A into gyro B)

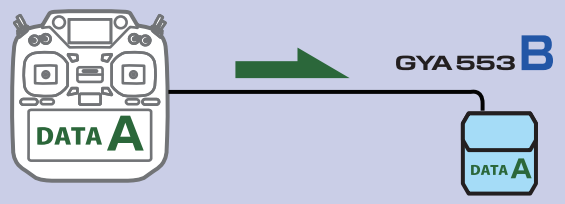

Home screen

On the home screen, basic information such as gyro operation mode, sensitivity, battery voltage are displayed.

Gyro operation mode / Gyro gain

Displays "AVCS" or "Normal" operation mode and gyro gain of aileron (roll), elevator (pitch) and rudder (yaw) axis.

GYA553 Software version

The software version of the connected GYA553 is displayed.

Battery voltage

Displays the voltage of the receiver battery connected to GYA.

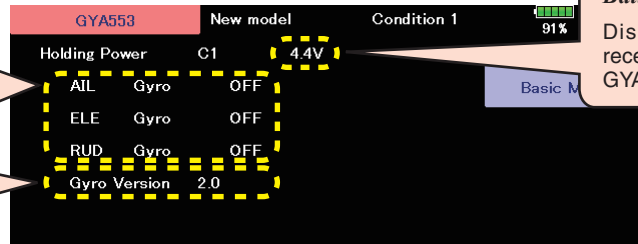

Basic menu

Home screen

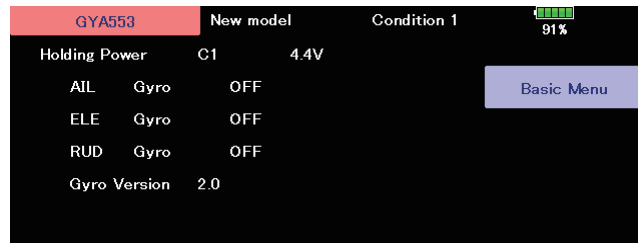

Basic menu

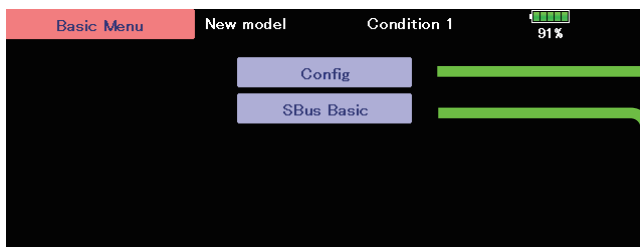

◆ Config

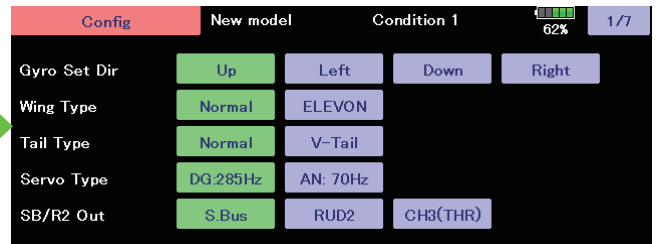

◆ S.BUS basic

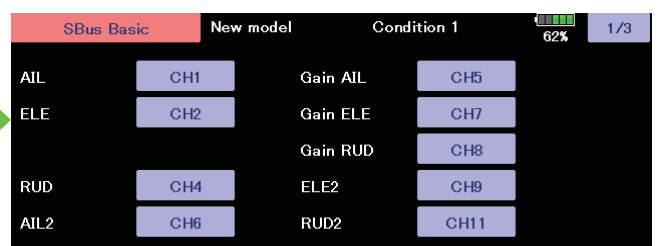

Config 1/7 Gyro set mounting direction

Config	New model	Condition 1	62%	1/7
Gyro Set Dir	Up	Left	Down	Right
Wing Type	Normal	ELEVON		
Tail Type	Normal	V-Tail		
Servo Type	DG:285Hz	AN: 70Hz		
SB/R2 Out	S.BUS	RUD2	CH3(THR)	

Set the mounting direction of GYA. Set mounting direction with reference to figure below.

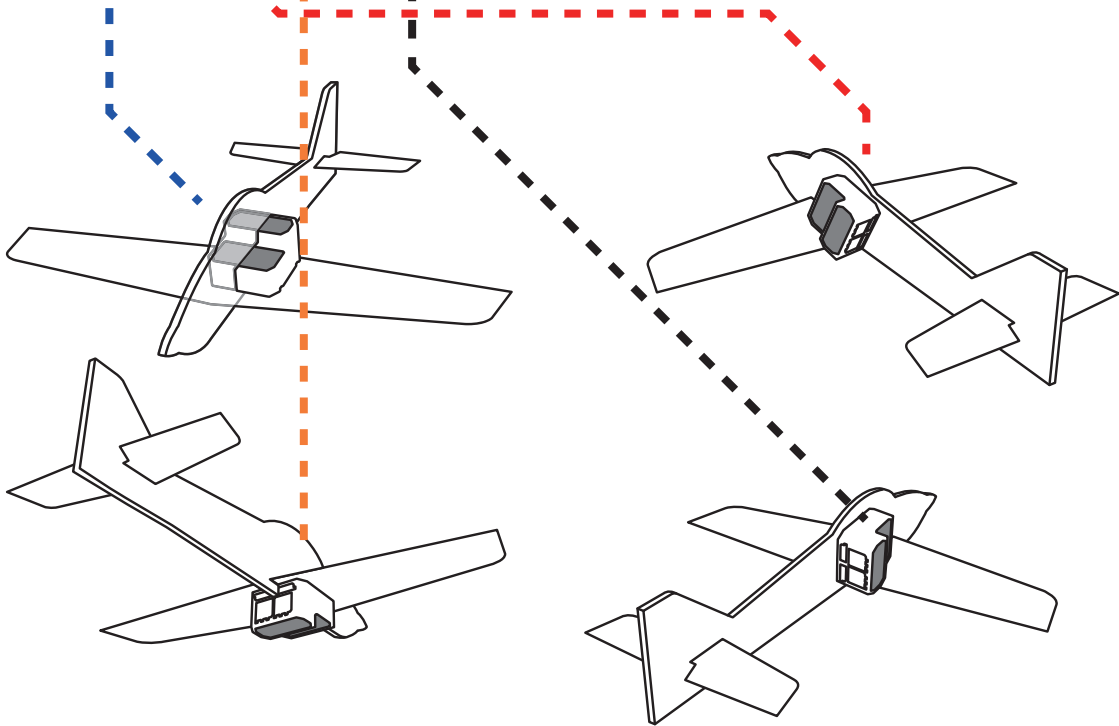

Config 1/7 WING/TAIL

Set with the wing type/tail type of GYA553. The wing type/tail type of the transmitter is not used and is normal.

- Turn off the elevon/V-tail mixing on the transmitter side.
- Do not use transmitter sub-trim. Adjust using the gyro neutral offset.
- When using the S.BUS servo, you can also use the neutral offset function of the S.BUS servo setting parameters.

Config	New model	Condition 1	62%	1/7
Gyro Set Dir	Up	Left	Down	Right
Wing Type	Normal	ELEVON		
Tail Type	Normal	V-Tail		
Servo Type	DG:285Hz	AN: 70Hz		
SB/R2 Out	S.BUS	RUD2	CH3(THR)	

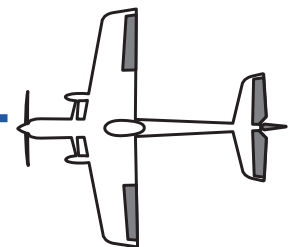

Select wing type

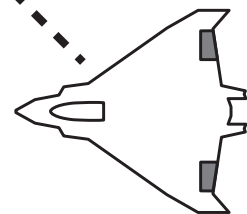

Select tail type



Config

Config 1/7 Servo type

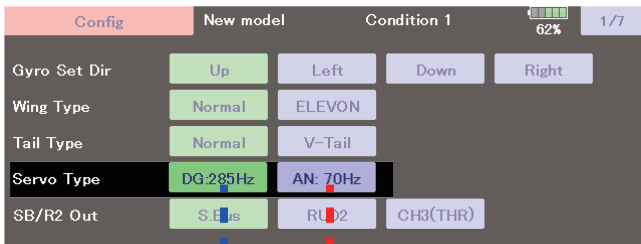

Select the servo type according to the servo to be used.

Digital servo → DG : 285 Hz

Analog servo → AN : 70 Hz

The stability of digital-servo mode of a flight increases in order to perform a high-speed control action.

Digital servo

Analog servo

Config 1/7 SB/R2 OUT

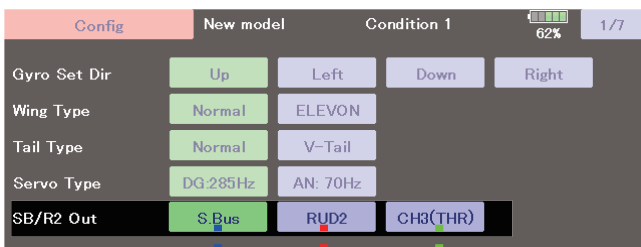

Select the SB/R2 port.

S.BUS
S.BUS devices can be connected to this port.

Rudder 2

Throttle

When using two rudder servos

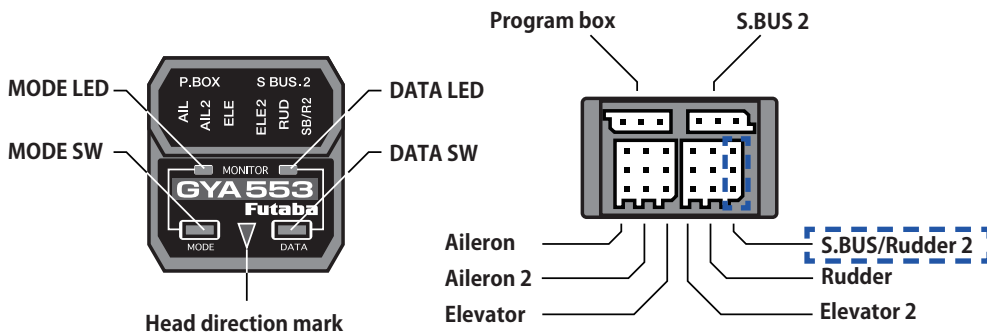

Config 2/7 Gyro direction

It is the direction setting of the gyro. Be careful as it will crash if the direction is reversed.

For dual aileron, dual elevator, and dual rudder aircraft, check the operating direction of each second aileron/elevator/rudder.

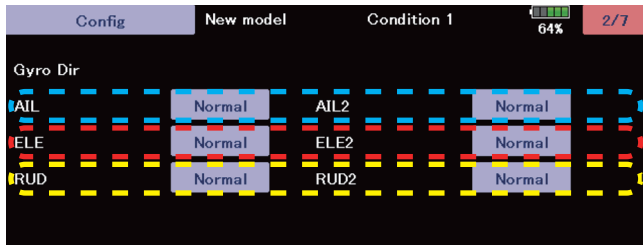

Tilt the airplane to the left on the ground and check that the ailerons operate to the right.

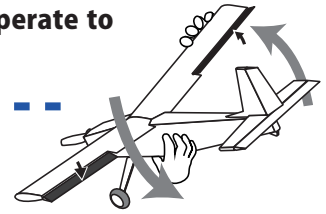

Turn the airplane to the right on the ground and check that the rudder operates to the left.

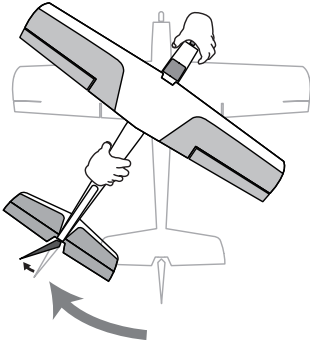

Raise the airplane with its nose upward and check that the elevator operates downward.

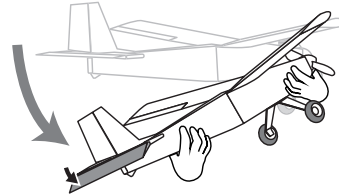

Config 3/7 Neutral offset

Neutral position setting for each servo.

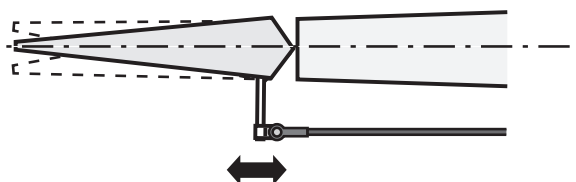
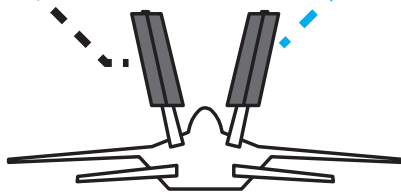
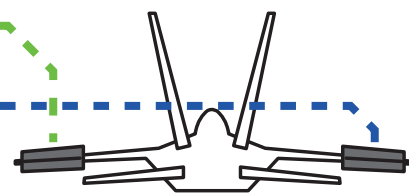
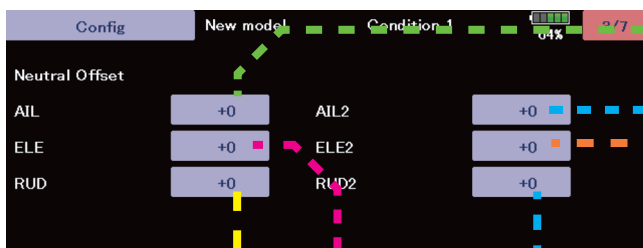

This will move the neutral to the desired position.

Config 4/7 5/7 Servo limit



This is the limit setting for each servo. The position of the maximum operation is read into the gyro in the first setting.



Aileron example

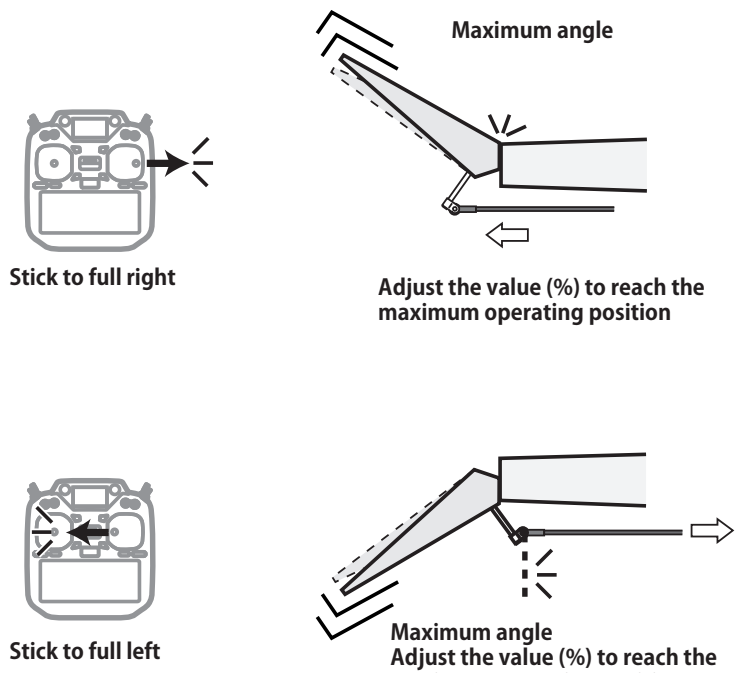

Config 6/7 Holding Power

It is a function to adjust the posture holding force of the aircraft in AVCS mode. Decreasing the value weakens the holding power and makes the operation feeling closer to the normal mode.

The current rate numbers C1 to C5 are displayed by operating the channel of the transmitter. Like the flight condition function of the transmitter, you can set up to 5 different data for the attitude holding force rate of the aircraft in AVCS mode by operating the switch from the transmitter, and switch between them. You can set the holding power rate selector switch to the channel with the AFR function of the transmitter, and set the point for each rate on the AFR point curve to switch. It is also possible to use the flight condition function to work with the flight condition switch.

Config 6/7

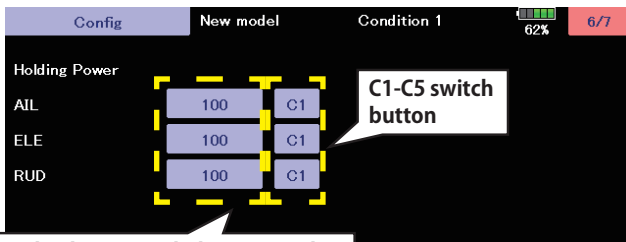

With the switch button, the "holding power" of each rate (C1 to C5) can be displayed and adjusted.

Display and adjust the current rate numbers C1 to C5 by operating the channel on the transmitter.

S.BUS Basic 2/3

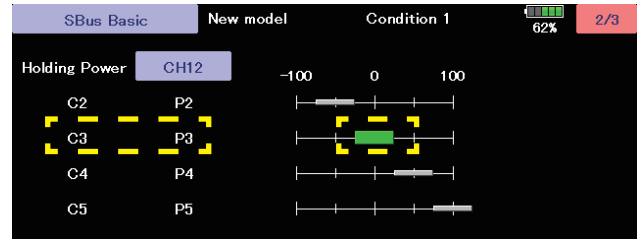

By operating the channel of the transmitter, the channel position of the current rate numbers C1 to C5 will be displayed in green.

When set to SW of DG1 or DG2

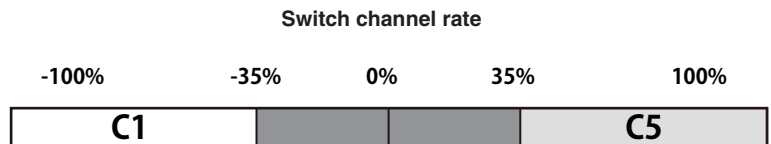
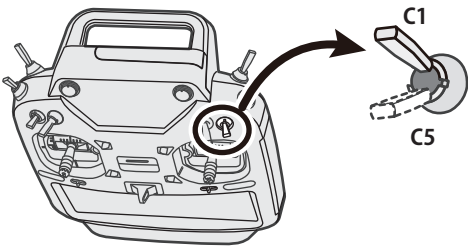

When set to dial or lever

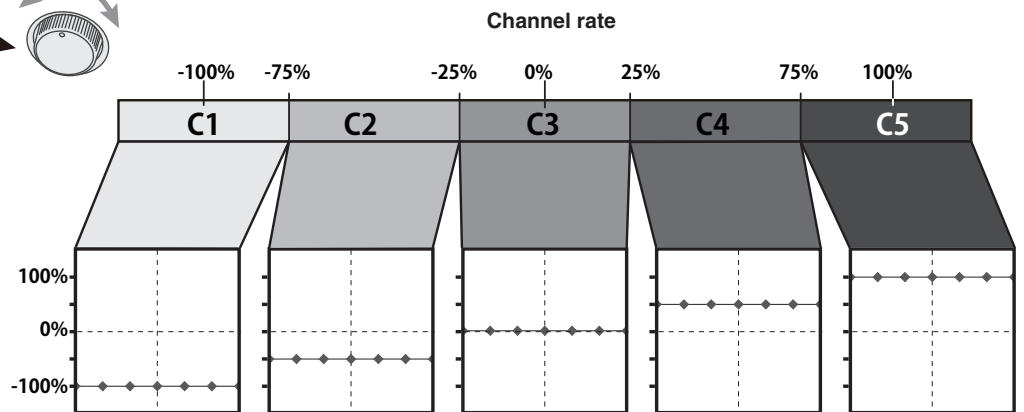
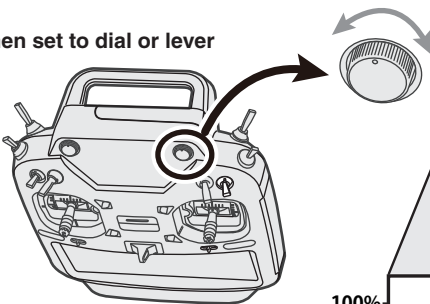

Config 7/7 Reset

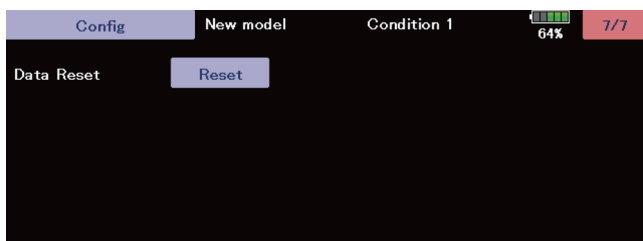

Reset each Config item. It returns to the initial value.

SBUS Basic menu

Set the CH for each function according to the transmitter to be used. Any unused functions should be set to INH (Inhibited).

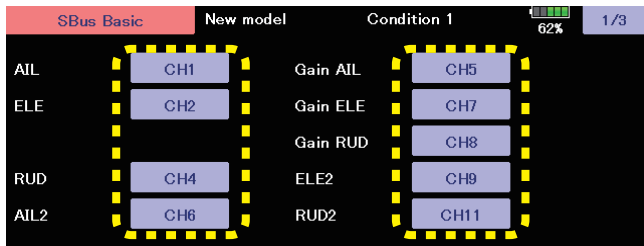

⚠ WARNING

❗ Always verify that the S.BUS function assignments match your transmitter's function (in the FUNCTION menu) assignments. If any changes are made within the transmitter function assignments, then it will also be necessary to make the changes within the S.BUS function assignments. To change the channel, GYA553 and T32MZ must be connected.

The channel of each function can be changed.

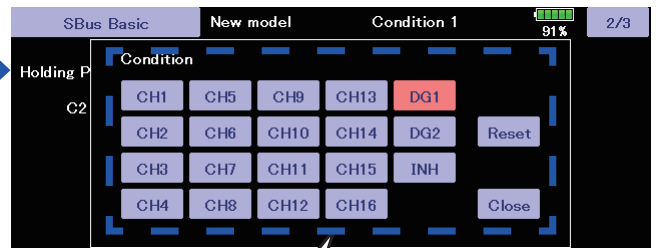
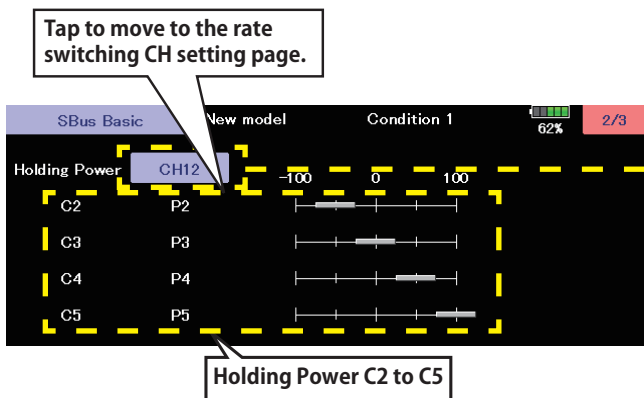

Tap the CH used for rate switching to select it.

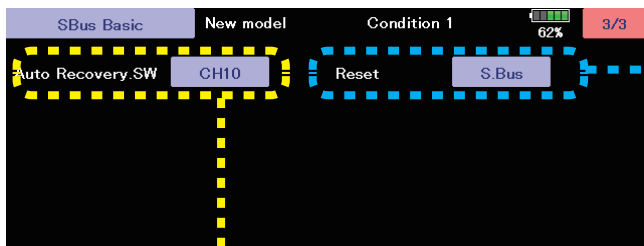

Reset each S.BUS function. It returns to the initial value.

ON-OFF channel for auto recovery

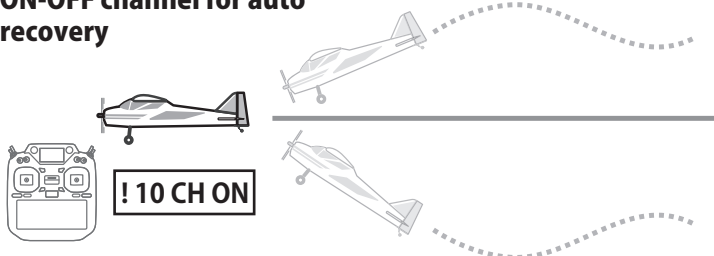

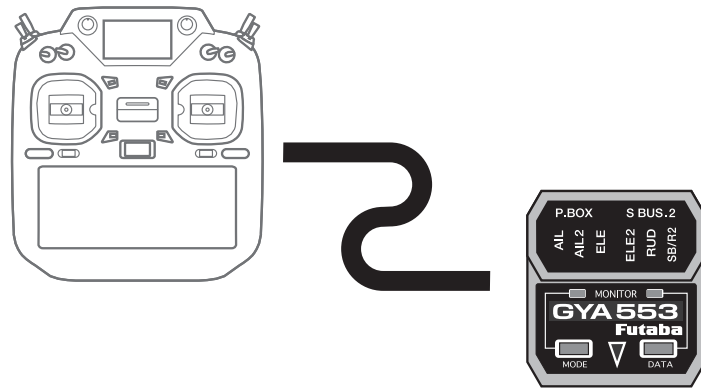

Futaba®