

How to update T32MZ

Your Futaba T32MZ transmitter programming can be updated easily and at no cost online. When functions are added or improved, the update file can be downloaded from our website. Copy the update files to the microSD card and then use the following procedure to update the program.

Check our web site for the FAQ regarding updating for more information.

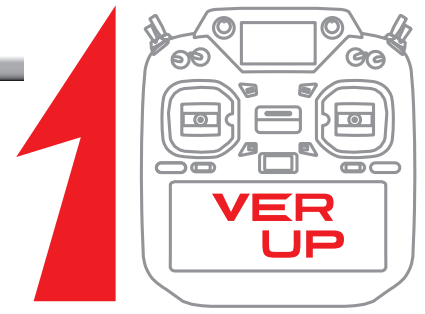

Updating procedure

Note: If the battery fully discharges during program updating, updating will fail. When the remaining battery capacity is 50% or less, always recharge the battery before updating.

Note: The model data in the transmitter can be used unchanged after updating, but to be safe, back up the model data before updating

1. Download the zip file of the update data from our website or your local distributor's website.

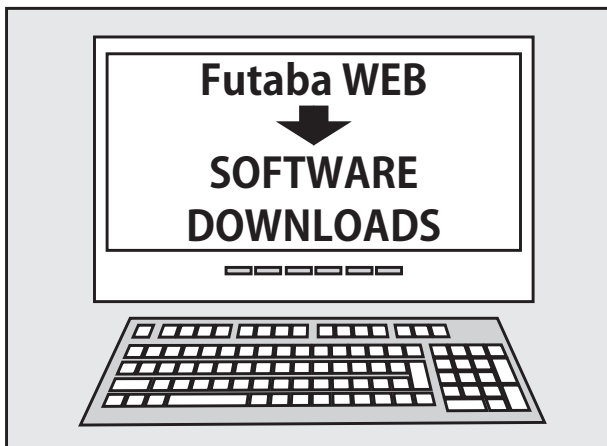

2. Extract the zip file on your computer.
3. The "Update" folder will be created on your computer.



4. Copy the "Update" folder onto your microSD card.

5. Insert the microSD card containing the update file into the card slot.

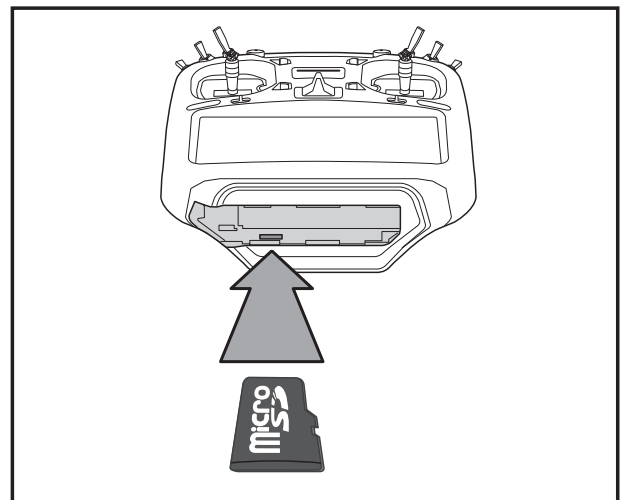

6. Press the HOME/EXIT button first. And next turn on the transmitter power.

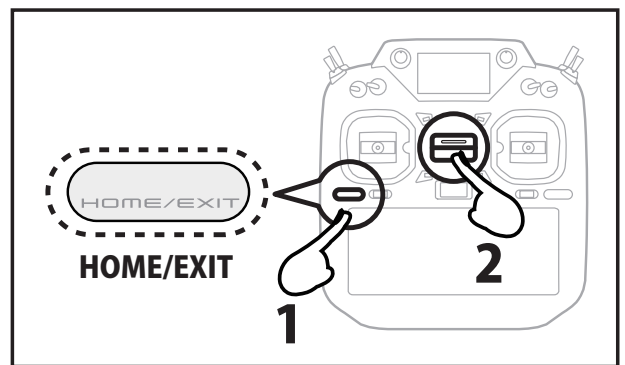

7. Keep pressing the HOME / EXIT button.

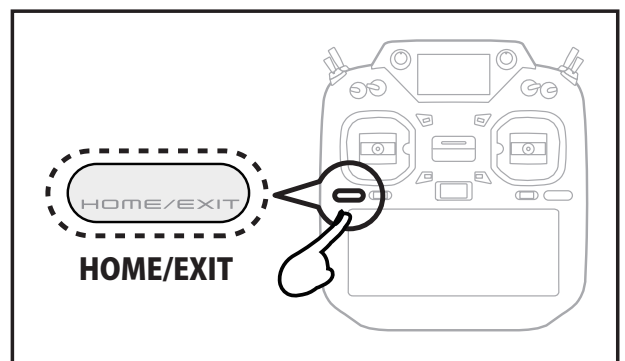

- 8.** Release the HOME / EXIT button when "Push any button to start the update."

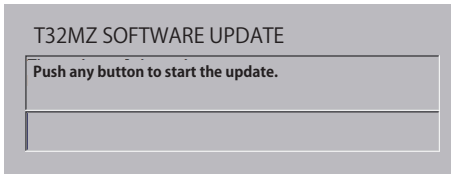

- 9.** Press the HOME / EXIT button or U.MENU/MON button.

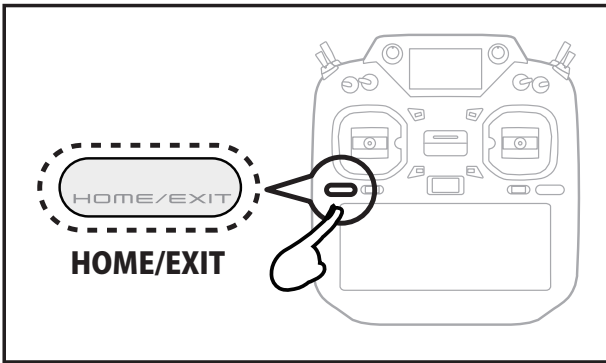

- 10.** The update starts and the screen changes as follows.

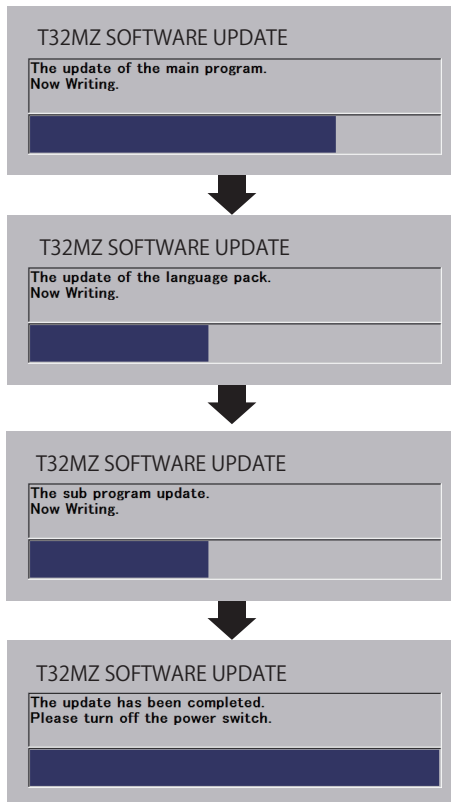

- 11.** When the update completion message appears, turn off the power and remove the microSD card.

- 12.** Be sure to check the each function before use.



Don't disconnect or remove the battery and microSD card from the transmitter during the update.

*** Voice data will be installed when the power is turned on for the first time after the update. No special operation is required, so please wait for a while. From the second time onward, the power will be turned on as usual.**

This software updates or alters the functions and features noted below. The instructions and information that follow are meant as a supplement to the original instruction manual that accompanied the T32MZ transmitter. Please refer to the original instruction manual where applicable, but replace the steps indicated below with these instructions. Please note that the software update will be finalized the first time that the T32MZ is powered up, after the software has been applied. As such, it may require a few moments before the Start screen appears. Please check to ensure that the update has been installed.

- 1) Select the System Menu.
- 2) Touch the [Information] button.
- 3) Confirm that the information in the display indicates the Editor and Encoder version numbers as noted above.

1.Fixed user menu issue.

Fixed a bug that some screens registered in the user menu were not displayed when loading model data of V3.3.1 or earlier with T32MZ with software version V3.4.0 or later.

For software versions V3.4.0 to V3.6.0, re-register the screens that are not displayed in the user menu.

1. GYA553 New firmware Version 2.x support. → Refer to T32MZ GYA553 V2 Setting manual

- 1. CH3 (THR) can be output to the RUD2 / S.BUS2 port.
- 2. The Holding Power rate of the aircraft in AVCS mode has been expanded to 5 types from C1 to C5, and each rate can be set by switching the display.
- 3. Added the setting of switching CH of Holding Power rate C1 to C5 to S.BUS basic menu.

◆ Config screen There are 7 pages in total, and the additional functions are 1 page and 6 pages.

The software version of the connected GYA553 is displayed.

Tap to the basic menu

Added CH3 (THR) to the output item of RUD2 / S.BUS port

◆ Basic Menu screen

To "Config"

To "SBus Basic"

C1-C5 switch button

With the switch button, the "holding power" of each rate (C1 to C5) can be displayed and adjusted.

Added the setting of switching CH of holding power rate C1 to C5 to S.BUS basic menu.

◆ S.BUS Basic screen

The second page has been added, and the total number of pages has changed from 2 to 3.

Additional page

Tap to move to the rate switching CH setting page.

Holding Power C2 to C5

Tap the CH used for rate switching to select it.

The current rate numbers C1 to C5 are displayed by operating the channel of the transmitter.

Like the flight condition function of the transmitter, you can set up to 5 different data for the attitude holding force rate of the aircraft in AVCS mode by operating the switch from the transmitter, and switch between them. You can set the holding power rate selector switch to the channel with the AFR function of the transmitter, and set the point for each rate on the AFR point curve to switch. It is also possible to use the flight condition function to work with the flight condition switch.

Config 6/7

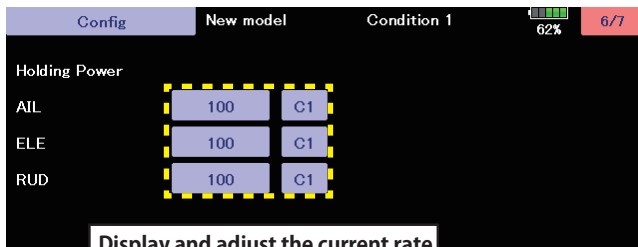

Display and adjust the current rate numbers C1 to C5 by operating the channel on the transmitter.

S.BUS Basic 2/3

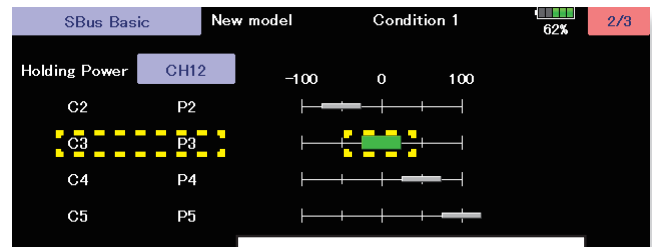

By operating the channel of the transmitter, the channel position of the current rate numbers C1 to C5 will be displayed in green.

When set to SW of DG1 or DG2

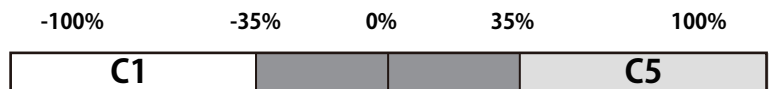
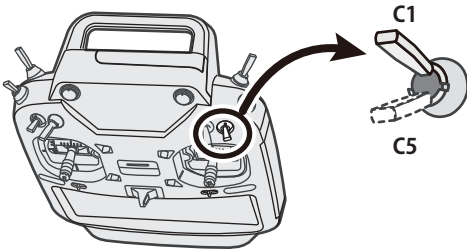

When set to dial or lever

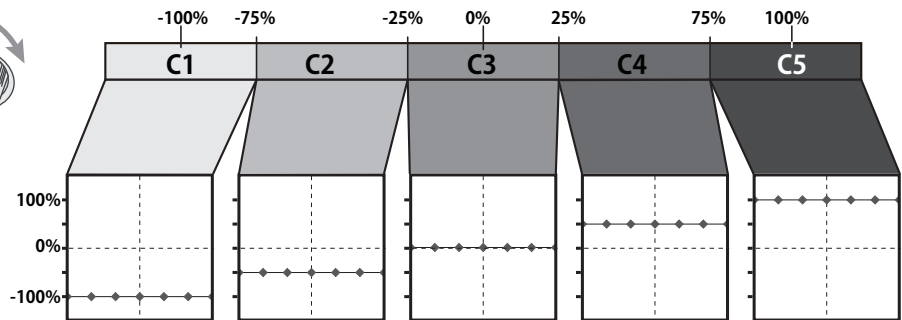
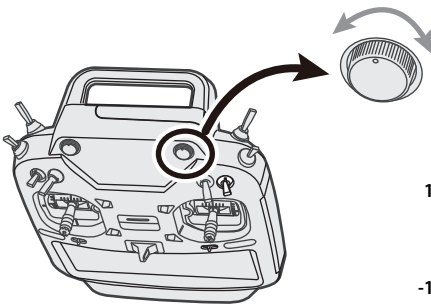

2. O.S.ENGINE EM-100 New firmware Version 9.11 support.

If you have used the EM-100, the update will unregister the EM-100 from the "Sensor" screen. Register the EM-100 again on the "Sensor" screen.

1.Fixed an issue where the integration timer malfunctioned while the screen was off.

1.Fixed the display of the sub display.

1. Futaba ESC, Hobbywing ESC telemetry compatible

Supports the telemetry function of the Futaba sensor "Futaba ESC" and the Hobbywing sensor "Hobbywing ESC".

Corresponding Futaba ESC

For details on Hobbywing ESC telemetry support, refer to the Hobbywing website.

Futaba ESC

MC-980H/A MC-9130H/A MC-9200H/A

◆ Register the ESC with the transmitter.

Linkage menu → Sensor → 2/2

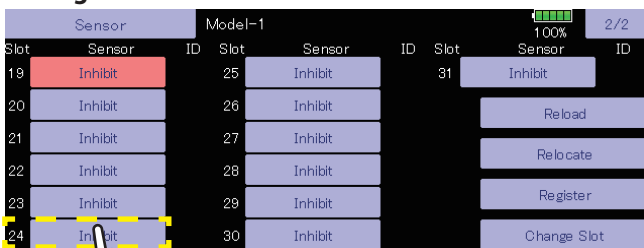

Tap the slot 24

◆ If slot 24 is used for another sensor

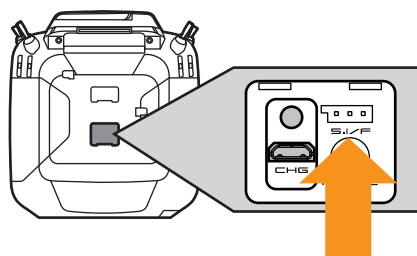

Connect the SBM-2 to the S.I / F port on the back of the transmitter.

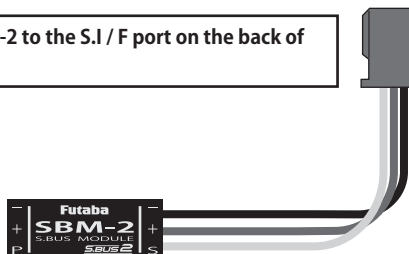

Linkage menu → Sensor → 2/2

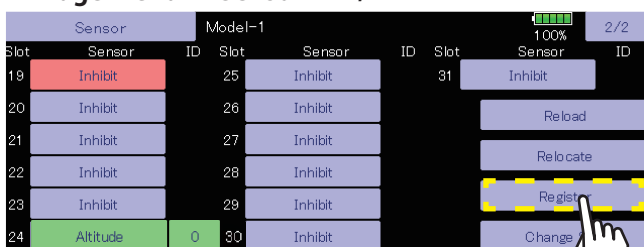

Tap register

1. Select **[Sensor]** on the second page of the linkage menu.
2. Open the second page of the sensor screen and tap the **Slot 24** button.
3. A list of sensors will be displayed, so select **Futaba ESC**.

1. Connect the **SBM-2** to the **S.I/F** port in the rear of the transmitter.
2. Open the sensor unit setting screen by touching the **[Sensor]** button in the Linkage Menu.
3. Touch the 1/2 to enter the second page of the Sensor screen. Then, touch the **[Register]** button.
4. If registration is successful, the following screen will appear. **"The registering succeeded."** Close the message by touching the [Close] button.

5. If registration failed, a screen like the following will appear: **"There are not enough available slots"**

SBM-2 require 8 slots for their operation. If continuous slots are not available, SBM-2 will not be registered accordingly. If there are unused slots, but they are not continuous, please use the Sensor Unit Reallocation feature, which follows, to change the slots of the existing sensors to accommodate the sensors which require continuous slots.

-**SBM-2**: 8 slots required

"The connected sensor is not ready"

No response from sensor unit. Check the connections.

◆ **The registered ESC will be displayed as "Futaba ESC".**

The registered Hobbywing ESC is displayed as "Hobbywing ESC".

For details on Hobbywing ESC telemetry support, refer to the Hobbywing website.

◆ MC-9130H/A telemetry connection example

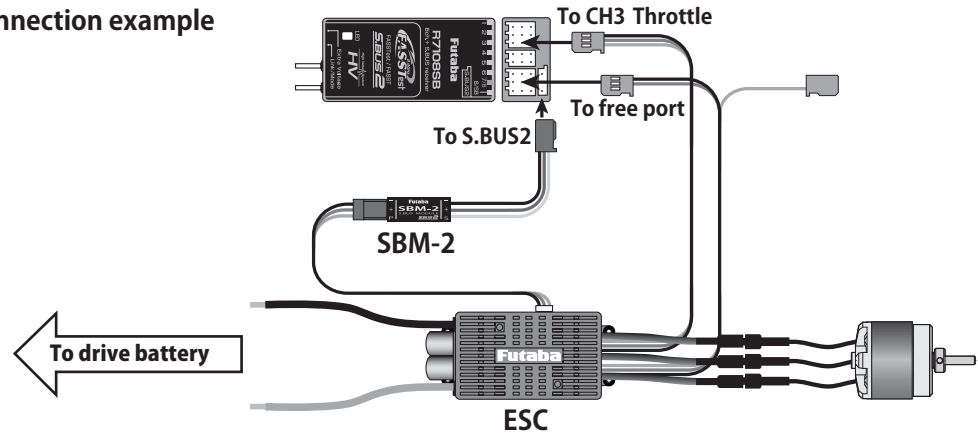

◆ ESC telemetry display screen

The ESC status is displayed. Alarm setting is also possible.

• Press to setup vibration alerts. 4 types of vibration selections are possible.
 • INH → ACT ;When activated a voice alert will also sound in addition to the alarm.

- Display of each current numerical value
- This display is the maximum and minimum after starting reception until the transmitter is turned off.
- A up arrow shows that the alarm operates, when the set value is exceeded.
- A downward arrow shows that the alarm operates, when less than the set-up numerical value.

◆ **Current Vpitage**

16. Futaba ESC New model-1

Current	Alert	Threshold	Vibration	Speech
0.0A ↑	INH	200.0A	OFF	INH
0.0 / 0.0A ↓	INH	-200.0A	OFF	INH

Voltage

Alert	Threshold	Vibration	Speech
INH	70.0V	OFF	INH
INH	0.0V	OFF	INH

Home 2: Select, Clear

• Change of a numerical value

- Press to setup an alert.
- Selects the sensor displayed on home 2 screen.
- Displays the maximum and minimum voltage ranges. [Clear] to reset.

◆ **Capacity RPM**

16. Futaba ESC New model-1

Capacity	Alert	Threshold	Vibration	Speech
0mAh ↑	INH	5000mAh	OFF	INH
0 / 0mAh ↓	INH	-5000mAh	OFF	INH

RPM

Alert	Threshold	Vibration	Speech
INH	2000rpm	OFF	INH
INH	0rpm	OFF	INH

Gear Ratio: 1.00 Pole: 2 Home 2: Select, Clear

*The current and capacity consumption display may vary depending on the usage conditions, so use it as a guide.

- If the gear is down, enter the gear ratio to display the helicopter rotor speed and the airplane gear down propeller speed.
- Enter the number of poles for your motor.

◆ **ESC Temperature**

16. Futaba ESC New model-1

ESC Temperature	Alert	Threshold	Vibration	Speech
0°C ↑	INH	150°C	OFF	INH
0 / 0°C ↓	INH	-20°C	OFF	INH

Home 2: Select, Clear

◆ **Throttle**

16. Futaba ESC New model-1

Throttle	Alert	Threshold	Vibration	Speech
0% ↑	INH	100%	OFF	INH
0 / 0% ↓	INH	0%	OFF	INH

State

- Throttle not at 0%
- Over temperature
- Motor locked
- Low voltage
- Over current
- Throttle signal lost

Alert: INH, Vibration: OFF Home 2: Select, Clear

- Shows the output level from the ESC to the motor, not the position of the throttle stick.
- Even if the stick is in the 50% position, the output may not be 50% depending on the ESC setting.

- When enabled, the alarm will be activated in the following warning state.
- When enabled, the vibrator will start in the following warning state.

◆ Warning state

Throttle not at 0%	When the throttle stick is not low when ESC is started
Low voltage	When the battery voltage is below the cutoff voltage
Over temperature	When the ESC temperature is 110 °C or higher
Over current	Peak current over
Motor locked	When the motor locks
Throttle signal lost	When no throttle signal is received for more than 0.25 s

2. Add R.P.M. display : Gov Basic

The number of revolutions of the governor setting is displayed on the governor basic screen of the gyro setting.

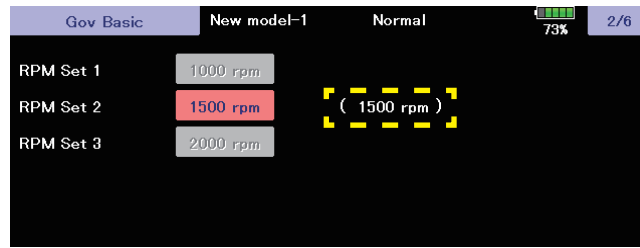

3. GYA553 Addition of setting parameters

AIL / ELE / RUD holding power setting has been added to the setting parameters of GYA553.

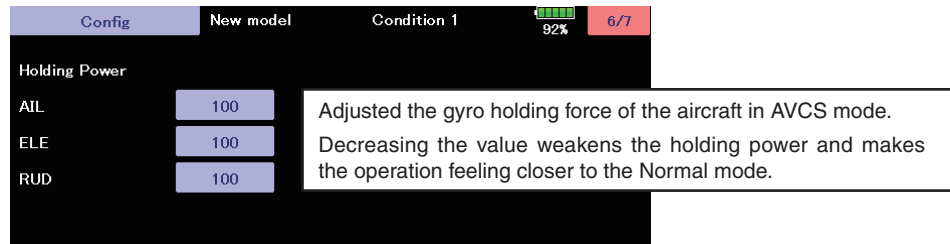

4. Expansion of governor R.P.M. range

With the governor function of the model menu, the R.P.M. range has been expanded to 700 to 3500 rpm.

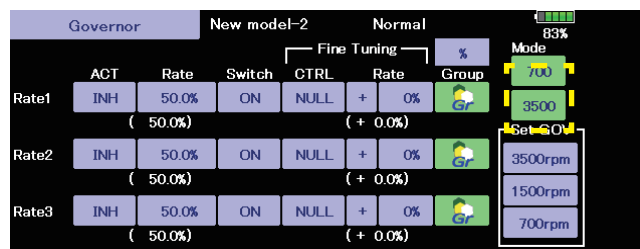

(Editor Version: 3.4 Encoder version: 1.2)

1. Add GYA553 Airplane Gyro setting function. (Refer the T32MZ GYA553 Setting Manual)

2. Compatible with SCORPION ESC telemetry

Added support for SCORPION POWER SYSTEM ESC some models.

3. Add power off switch press time setting

The power switch long press time when turning off the power can be selected from 1 second and 4 seconds.

[SYSTEM MENU] → [H/W Setting]

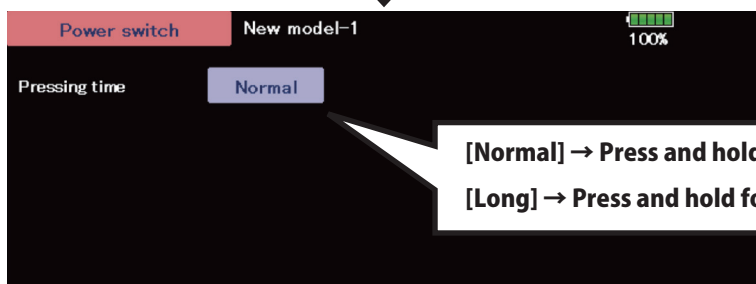
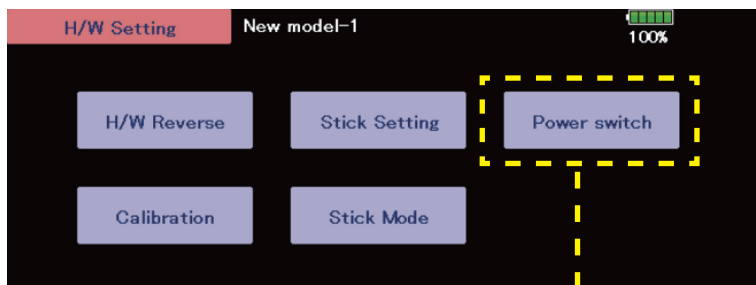

(Editor Version: 3.3.1 Encoder version: 1.2)

1. Fixed the CGY755/CGY760R Gyro setting function.

(Editor Version: 3.3 Encoder version: 1.1)

1. Add CGY755/CGY760R Gyro setting function. (Refer the T32MZ Ver 3.3 Gyro Setting Manual)

(Editor Version: 3.2.1 Encoder version: 1.1)

1. Fixed a defect on the screen off function.

(Editor Version: 3.2 Encoder version: 1.1)

1. Add Screen off function [Quick start]

This "screen off" can quick start next startup. This is convenient when turning on and off frequently. No RF output at "screen off". Also, there is no screen display. However, the battery is consumed because the internal circuit is activated.

Be sure to turn off the receiver first.

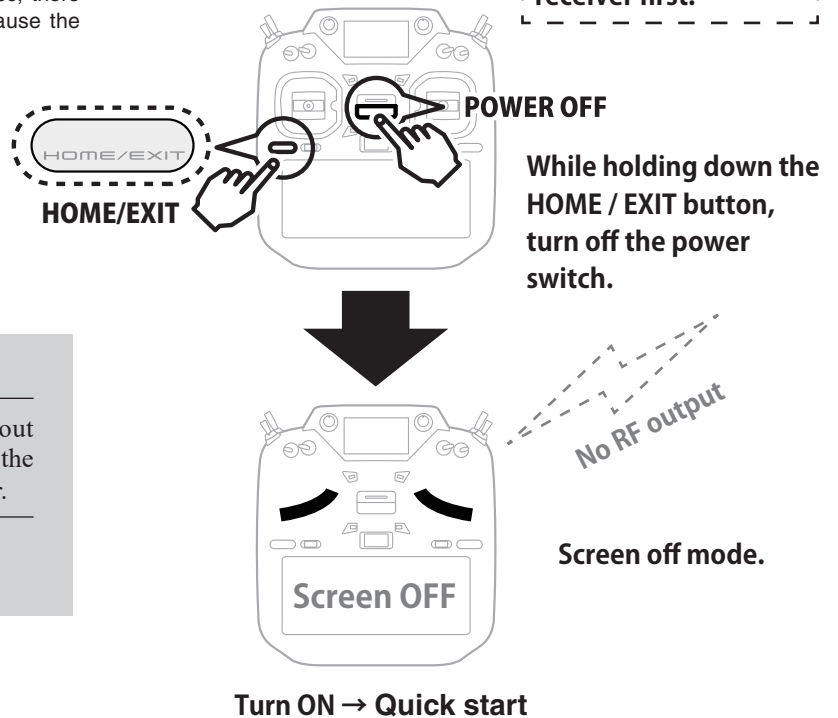

⚠ WARNING

- While in screen off mode, it consumes about 4% of the battery per hour. If you do not use the transmitter for a long time, turn off the power.
- Updates cannot be performed in screen off mode. To update, turn off the power.

2. Add Stop alarm : Telemetry RPM sensor setting

On the telemetry setting screen, if you enable the alarm setting on the low rotation side of the RPM sensor and set the alarm setting to 0, an alarm will be activated when the rotation speed becomes 0.

3. Chinese language support

Added support for Chinese display. You can select Chinese by updating to Chinese version software.

4. GPS display correction

Fixed an issue where GPS location information could not be recognized correctly.

5. Sub display External input voltage display correction

Fixed the problem that the voltage was displayed low when the external input voltage of the receiver on the sub-display exceeded 25.5V.

6. KS-01 (O.S.ENGINE)

Added support for a kill switch KS-01 made by O.S.ENGINE.